

# Kellergeschoss

6.1

6.2

6.3

6.4

6.5

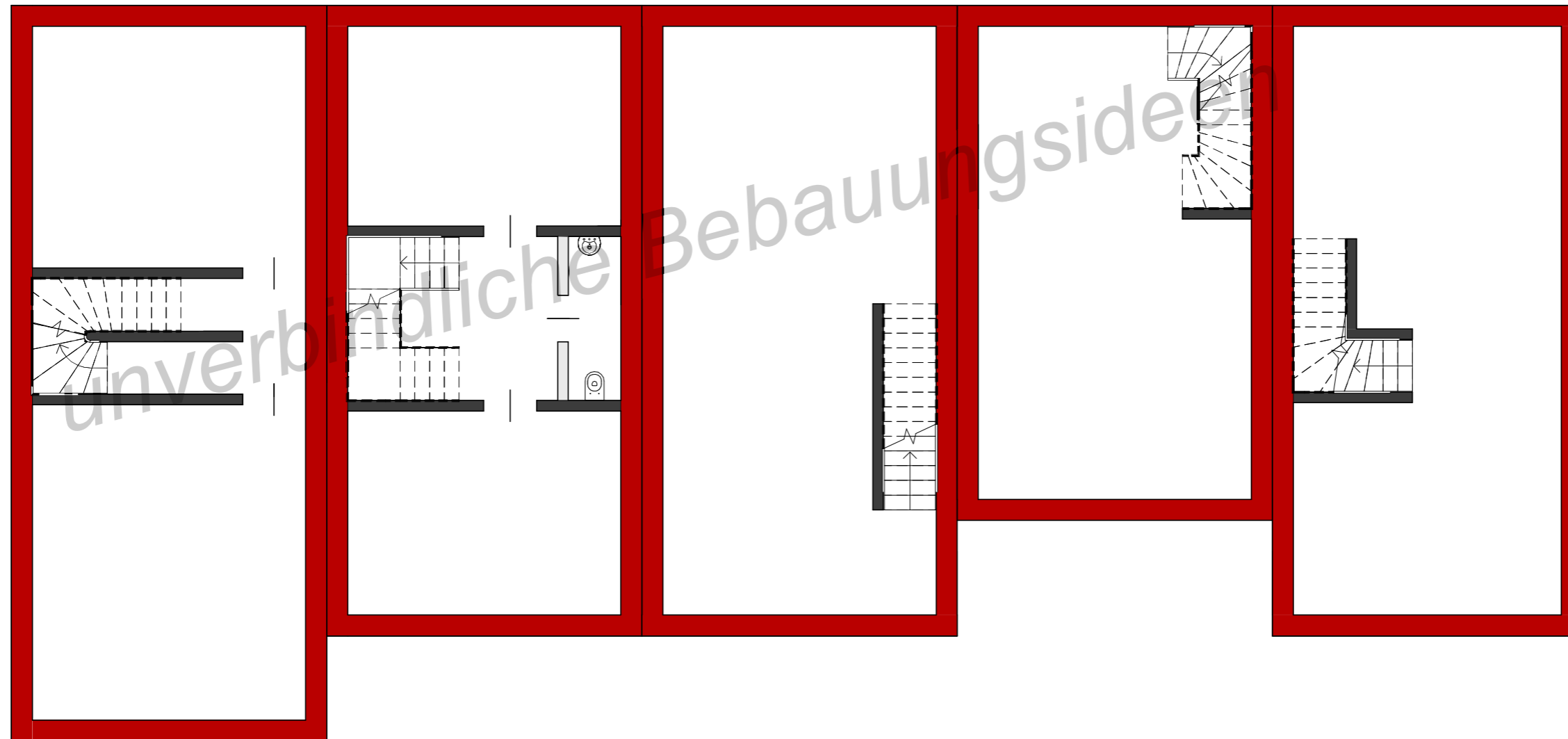

6.1 6.2 6.3 6.4 6.5

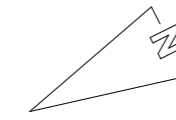
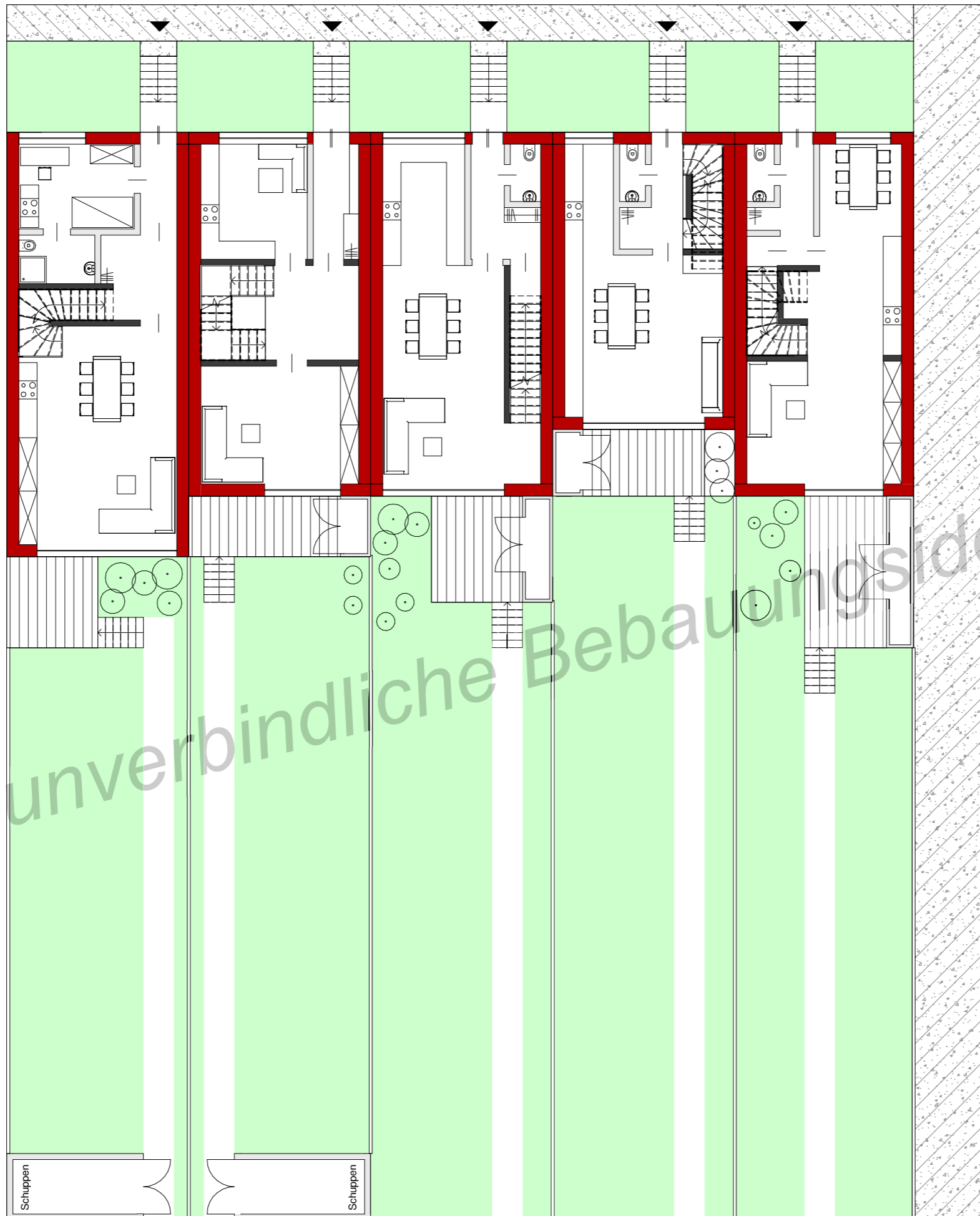

Erdgeschoss

# 1. Obergeschoss

6.1

6.2

6.3

6.4

6.5

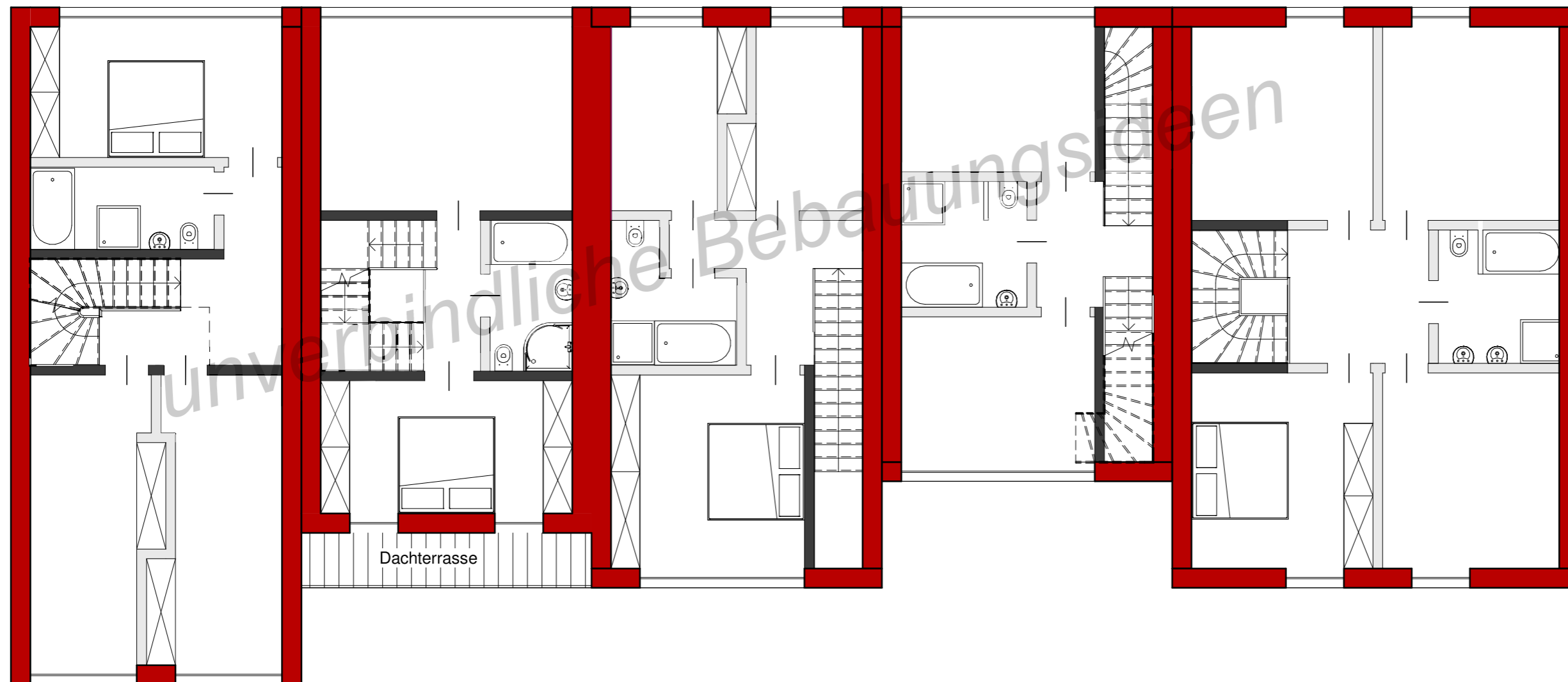
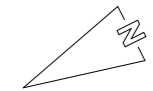

## 2.Obergeschoss

6.1

6.2

6.3

6.4

6.5

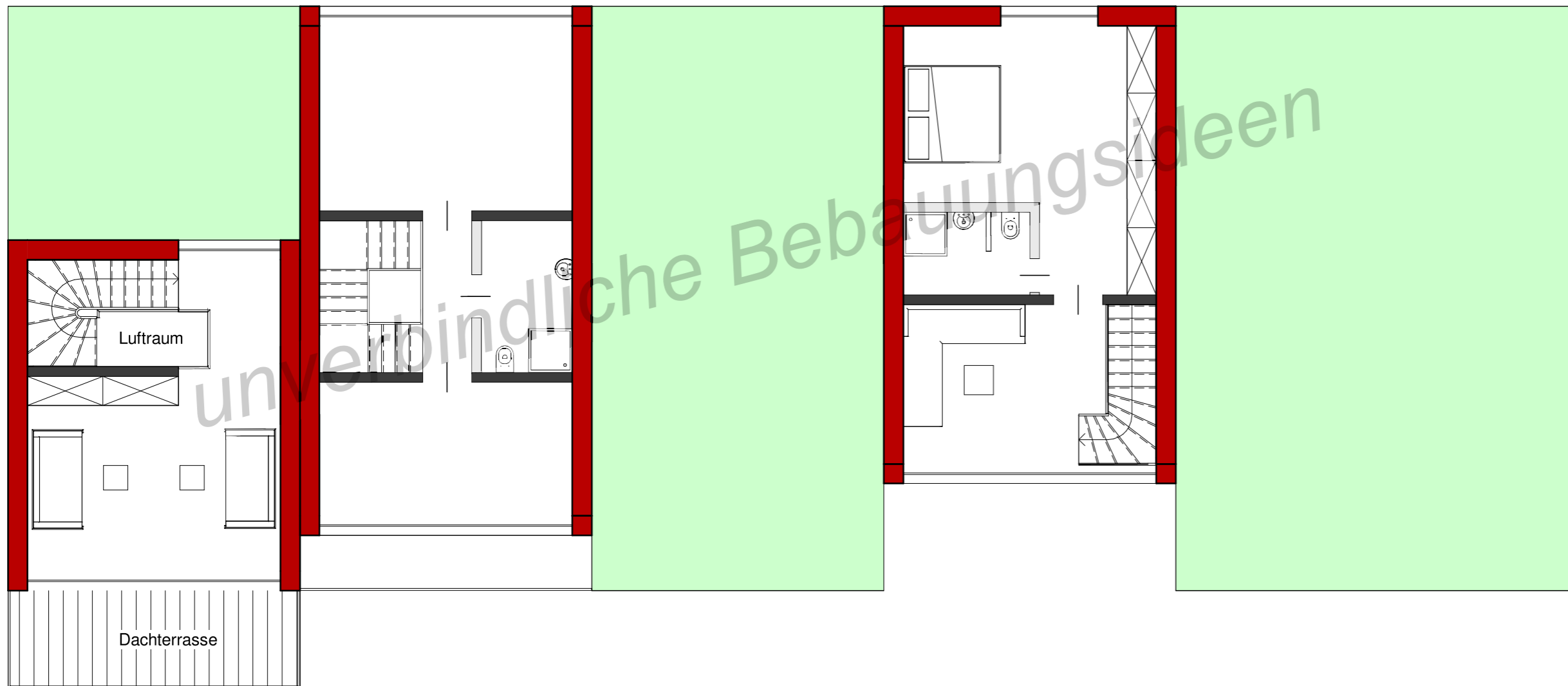
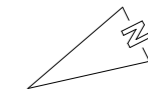

# Ansicht Straßenseite

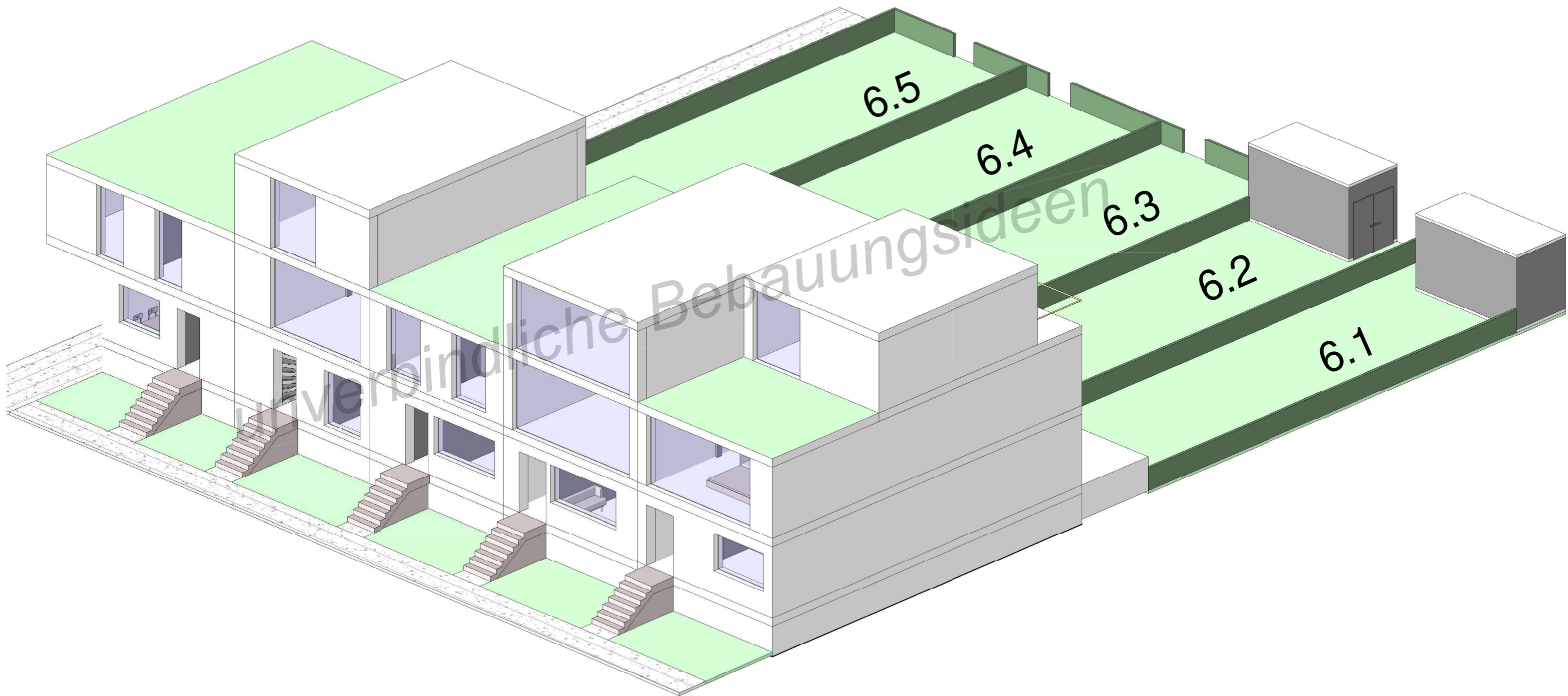

## Ansicht Gartenseite

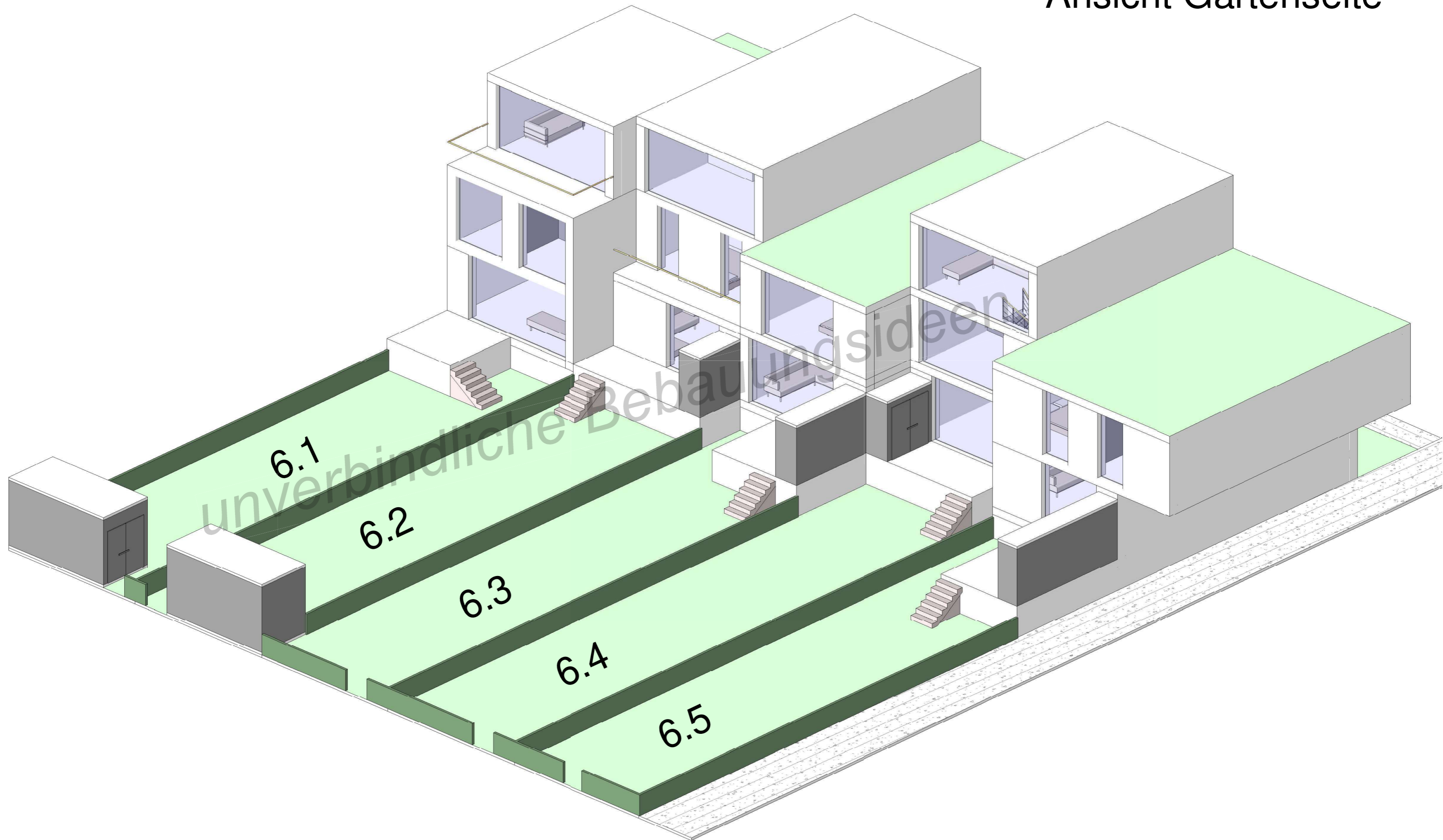

# Reihenhaus Typ 6.1

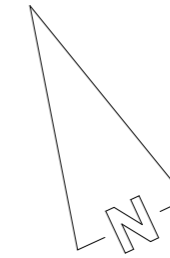

## 2.Obergeschoss

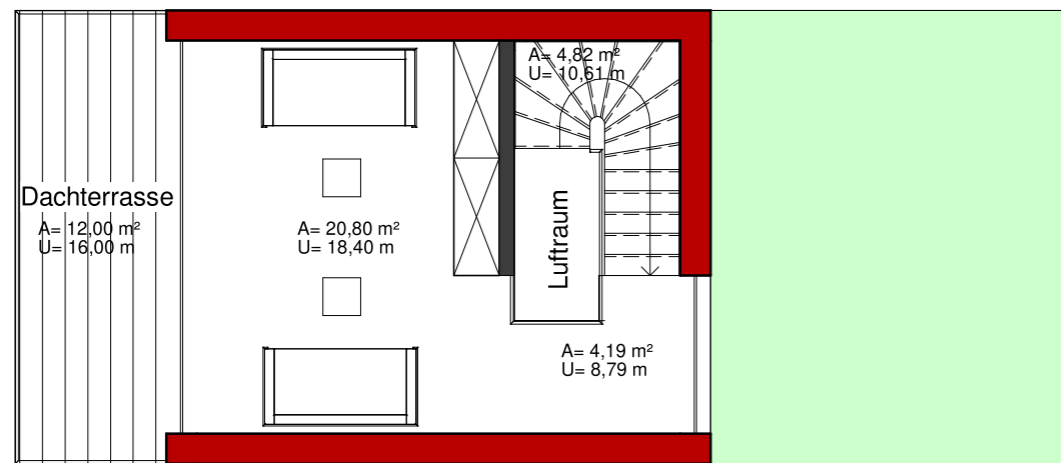

## 1.Obergeschoss

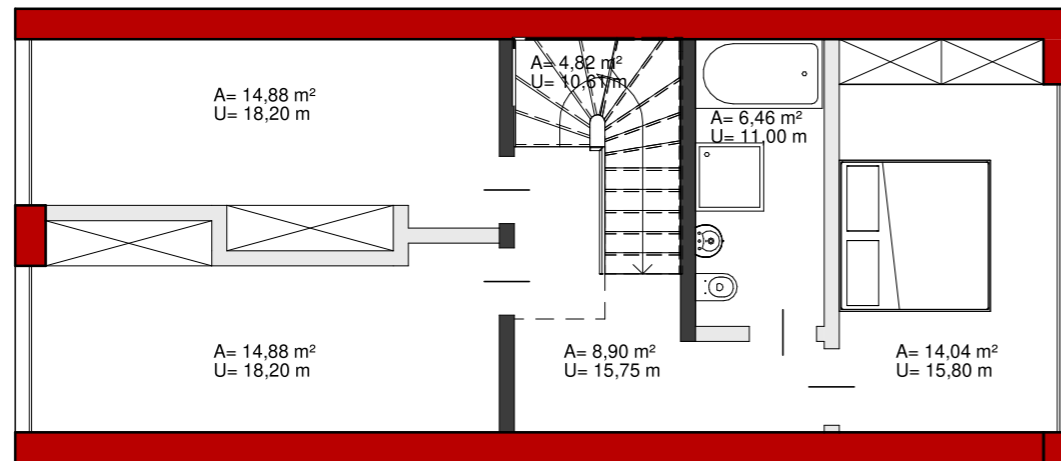

## Erdgeschoss

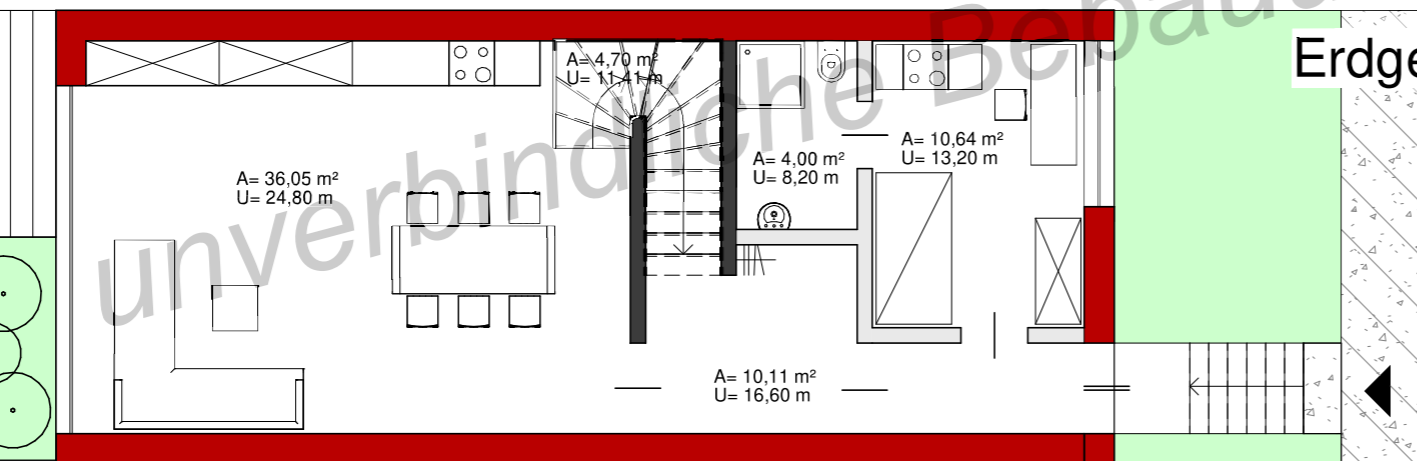

## Kellergeschoss

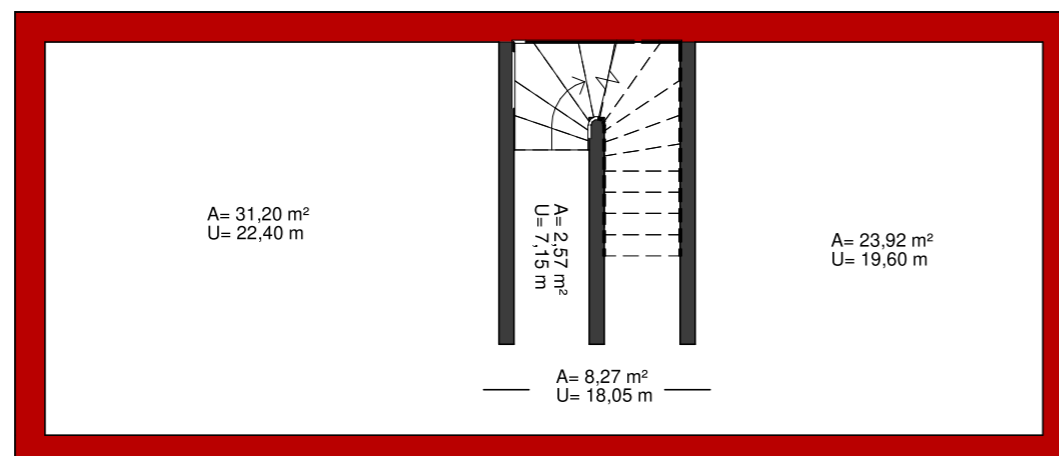

Raumbezeichnung	Fläche
-----------------	--------

Flur	2,57 m <sup>2</sup>
Flur	8,27 m <sup>2</sup>
Raum	31,20 m <sup>2</sup>
Raum	23,92 m <sup>2</sup>
1.KG	65,96 m <sup>2</sup>

Eingang	10,11 m <sup>2</sup>
Wohnen	36,05 m <sup>2</sup>
Sanitär	4,00 m <sup>2</sup>
Raum	10,64 m <sup>2</sup>
Treppe	4,70 m <sup>2</sup>
EG	65,50 m <sup>2</sup>

Flur	8,90 m <sup>2</sup>
Raum	14,88 m <sup>2</sup>
Raum	14,88 m <sup>2</sup>
Sanitär	6,46 m <sup>2</sup>
Schlafen	14,04 m <sup>2</sup>
Treppe	4,82 m <sup>2</sup>
1.OG	63,98 m <sup>2</sup>

Raum	4,19 m <sup>2</sup>
Wohnen	20,80 m <sup>2</sup>
Treppe	4,82 m <sup>2</sup>
2.OG	29,81 m <sup>2</sup>
Gesamt: 18	225,25 m <sup>2</sup>

# Reihenhaus Typ 6.2

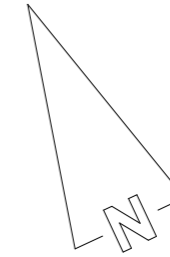

2.Obergeschoss

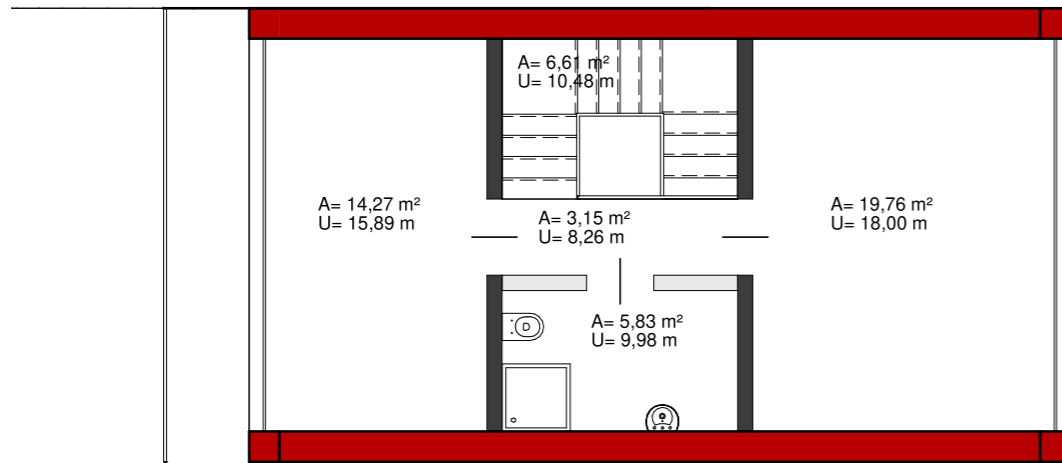

1.Obergeschoss

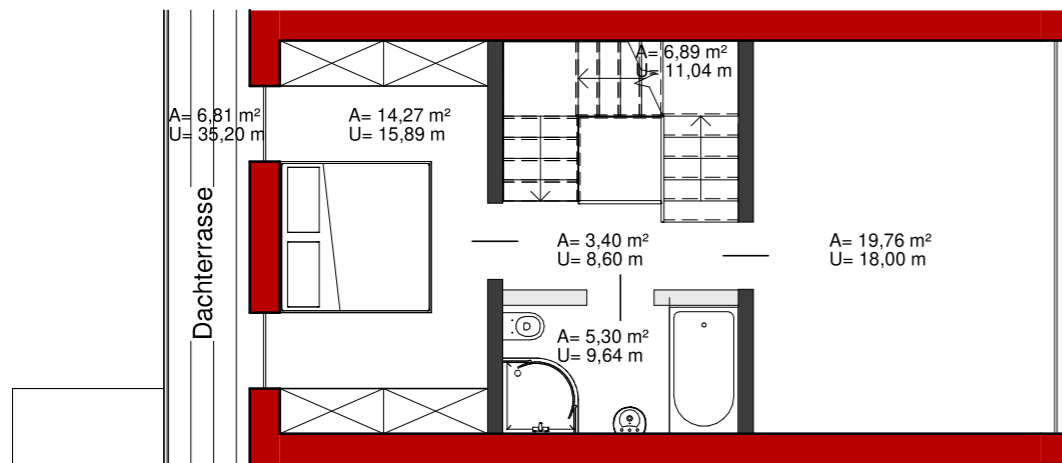

Erdgeschoss

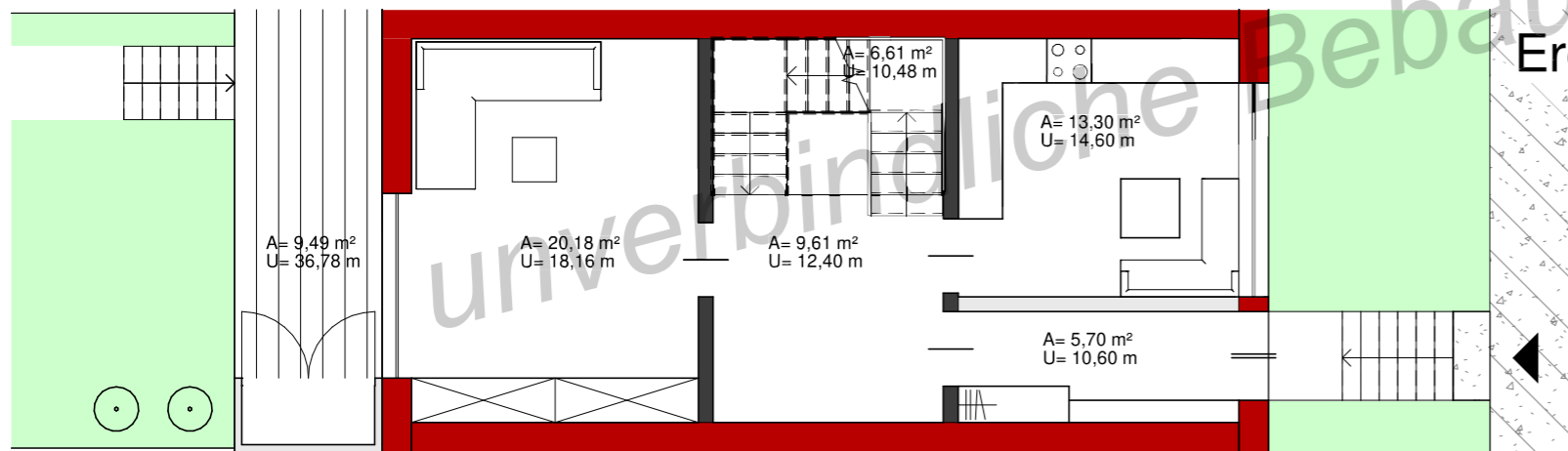

Kellergeschoss

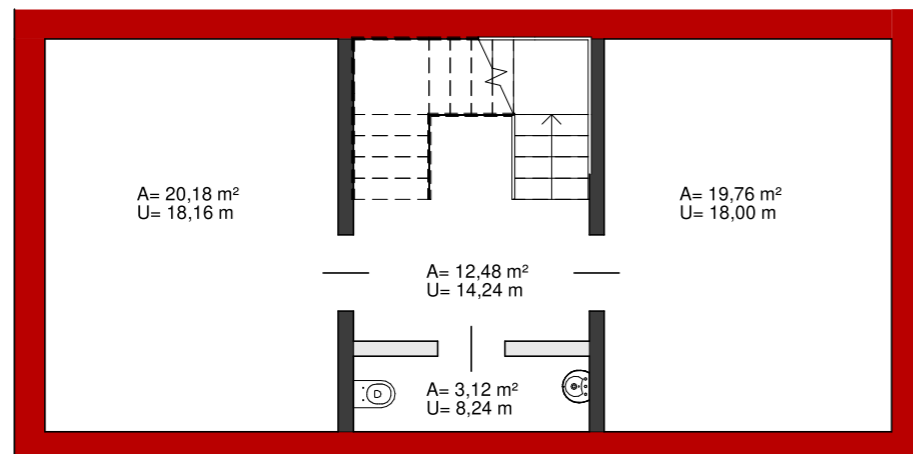

Raumbezeichnung	Fläche
-----------------	--------

Raum	12,48 m <sup>2</sup>
Raum	20,18 m <sup>2</sup>
Raum	19,76 m <sup>2</sup>
Sanitär	3,12 m <sup>2</sup>
1.KG	55,54 m <sup>2</sup>

Flur	5,70 m <sup>2</sup>
Aufenthalt	9,61 m <sup>2</sup>
Wohnen	20,18 m <sup>2</sup>
Küche	13,30 m <sup>2</sup>
Treppe	6,61 m <sup>2</sup>
EG	55,40 m <sup>2</sup>

Flur	3,40 m <sup>2</sup>
Raum	19,76 m <sup>2</sup>
Sanitär	5,30 m <sup>2</sup>
Schlafen	14,27 m <sup>2</sup>
Treppe	6,89 m <sup>2</sup>
Balkon	6,81 m <sup>2</sup>
1.OG	56,44 m <sup>2</sup>

Flur	3,15 m <sup>2</sup>
Raum	19,76 m <sup>2</sup>
Sanitär	5,83 m <sup>2</sup>
Raum	14,27 m <sup>2</sup>
Treppe	6,61 m <sup>2</sup>
2.OG	49,63 m <sup>2</sup>
Gesamt: 20	217,01 m <sup>2</sup>



# Reihenhaus Typ 6.3

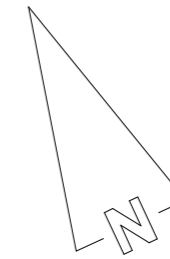

1.Obergeschoss

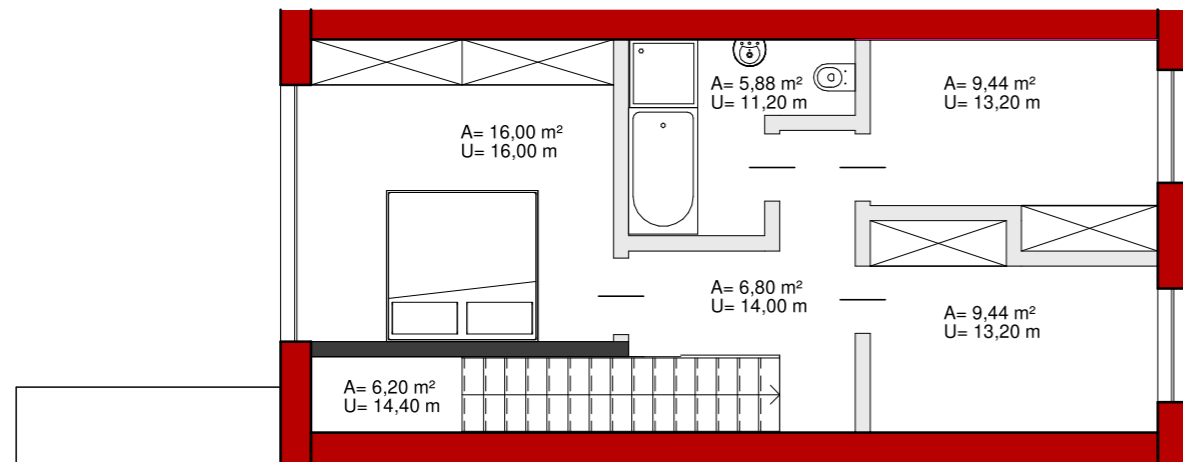

Erdgeschoss

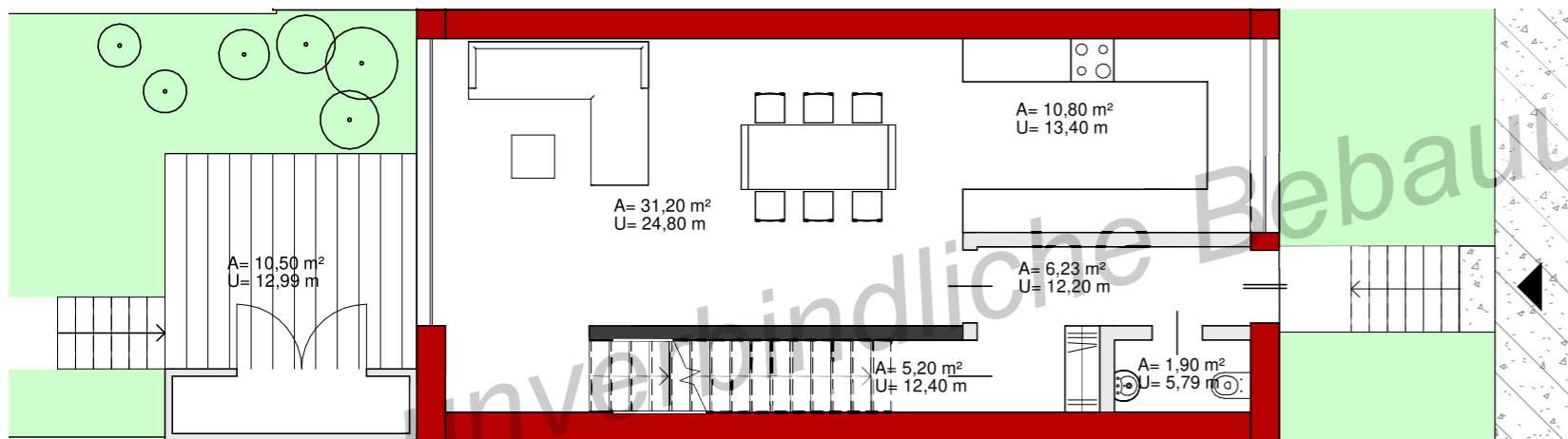

Kellergeschoss

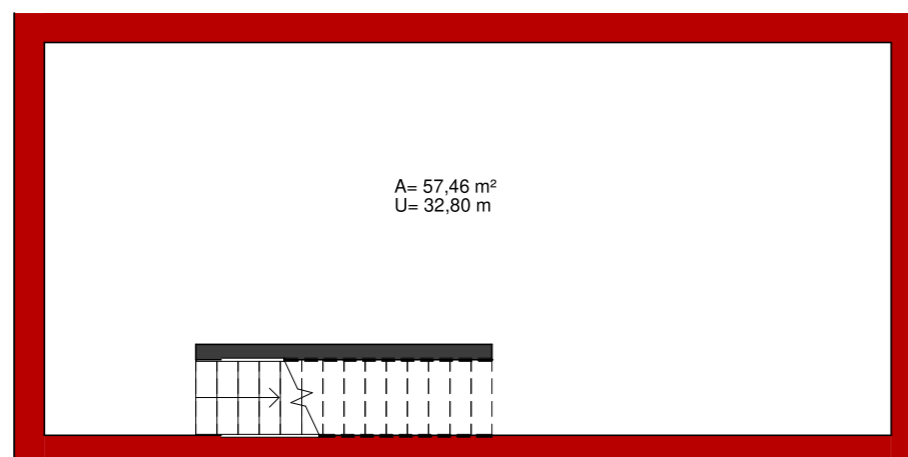

Raumbezeichnung	Fläche
-----------------	--------

Raum	57,46 m <sup>2</sup>
1.KG	57,46 m <sup>2</sup>

Flur	6,23 m <sup>2</sup>
Wohnen	31,20 m <sup>2</sup>
Küche	10,80 m <sup>2</sup>
WC	1,90 m <sup>2</sup>
TRH	5,20 m <sup>2</sup>
EG	55,32 m <sup>2</sup>

Flur	6,80 m <sup>2</sup>
Schlafen	16,00 m <sup>2</sup>
Sanitär	5,88 m <sup>2</sup>
Raum	9,44 m <sup>2</sup>
Raum	9,44 m <sup>2</sup>
Treppe	6,20 m <sup>2</sup>
1.OG	53,76 m <sup>2</sup>
Gesamt: 12	166,54 m <sup>2</sup>

# Reihenhaus Typ 6.4

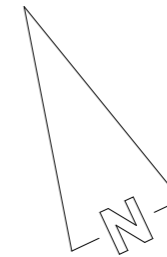

2.Obergeschoss

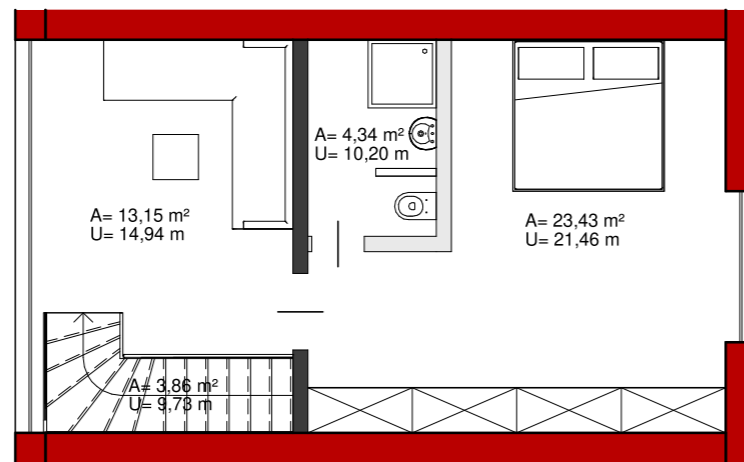

1.Obergeschoss

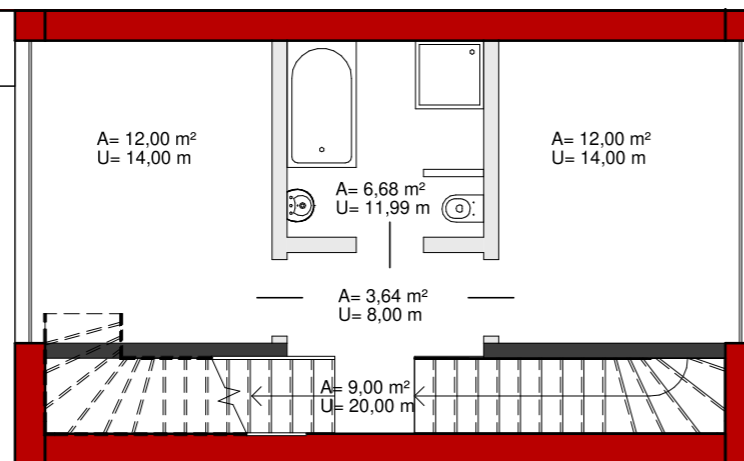

Erdgeschoss

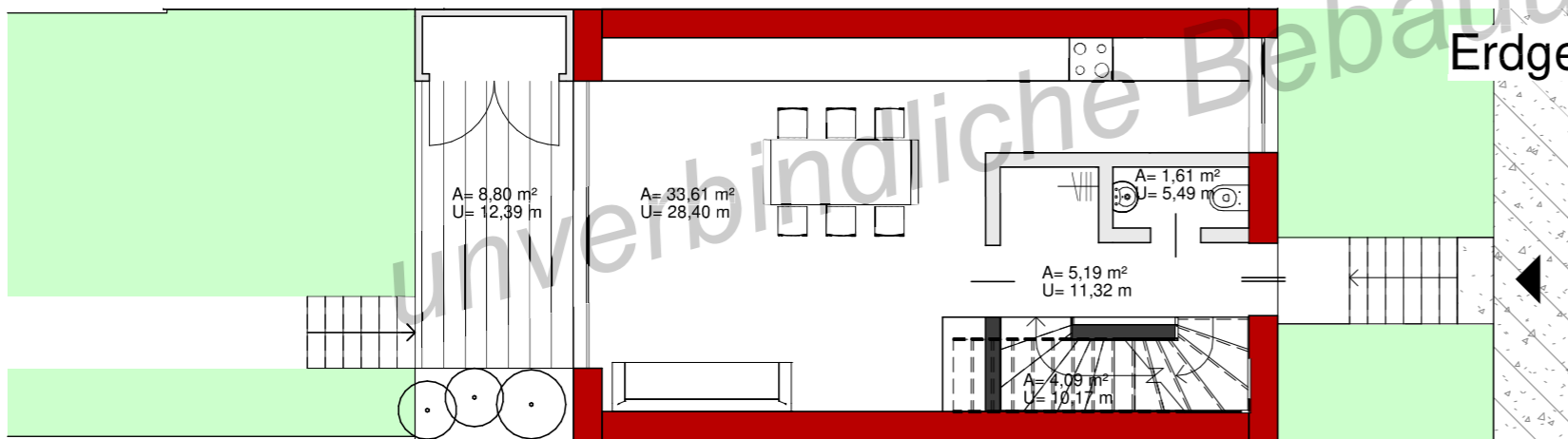

Kellergeschoss

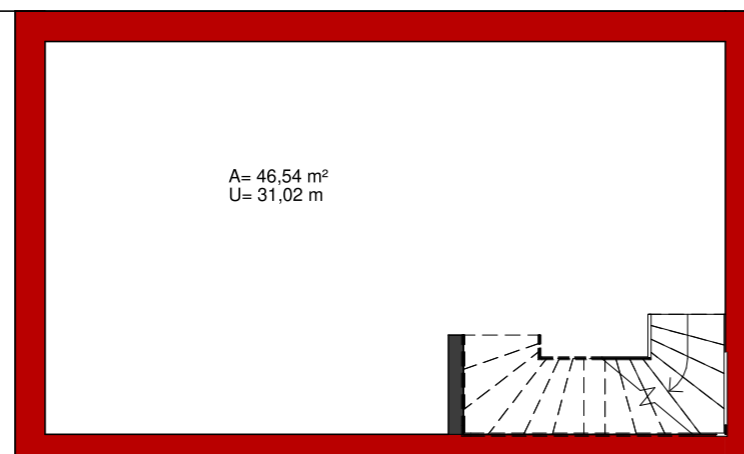

Raumbezeichnung	Fläche
-----------------	--------

Raum	46,54 m <sup>2</sup>
1.KG	46,54 m <sup>2</sup>

Flur	5,19 m <sup>2</sup>
Wohnen	33,61 m <sup>2</sup>
WC	1,61 m <sup>2</sup>
Treppe	4,09 m <sup>2</sup>
EG	44,51 m <sup>2</sup>

Flur	3,64 m <sup>2</sup>
Raum	12,00 m <sup>2</sup>
Sanitär	6,68 m <sup>2</sup>
Raum	12,00 m <sup>2</sup>
Treppe	9,00 m <sup>2</sup>
1.OG	43,32 m <sup>2</sup>

Wohnen	13,15 m <sup>2</sup>
Sanitär	4,34 m <sup>2</sup>
Schlafen	23,43 m <sup>2</sup>
Treppe	3,86 m <sup>2</sup>

2.OG	44,78 m <sup>2</sup>
Gesamt: 14	179,14 m <sup>2</sup>

1.Obergeschoss

Reihenhaus Typ 6.5

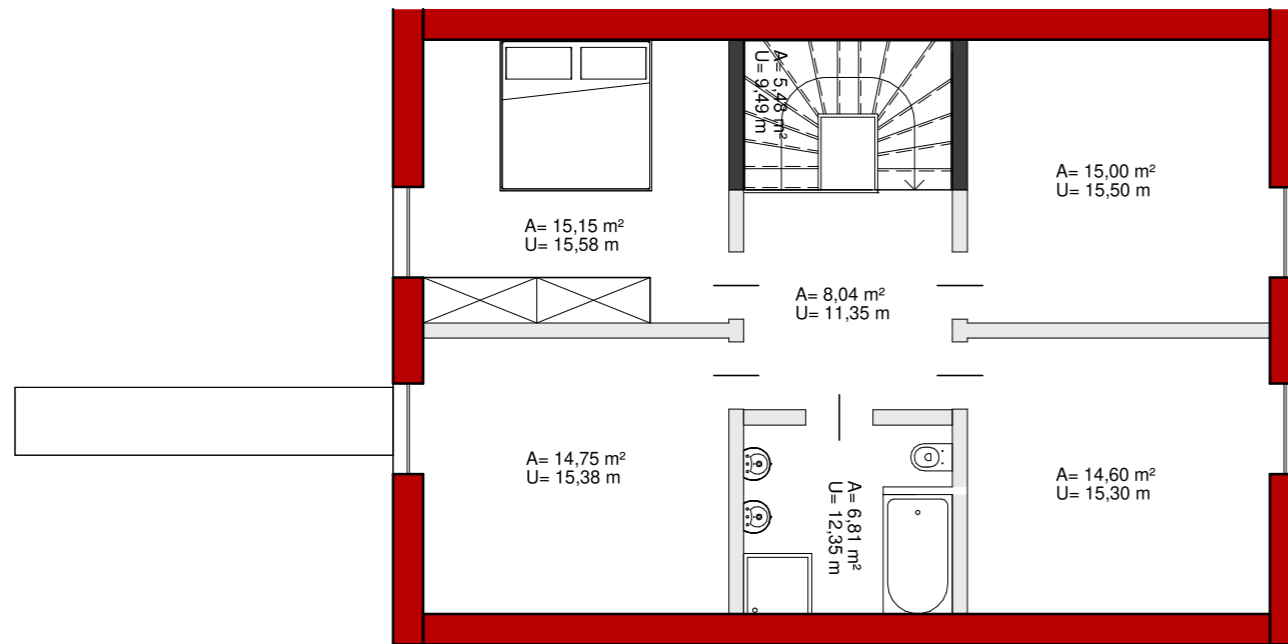
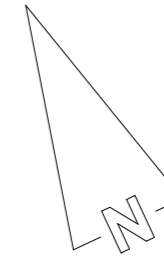

Raumbezeichnung	Fläche
-----------------	--------

Raum	56,07 m <sup>2</sup>
1.KG	56,07 m <sup>2</sup>

Flur	6,32 m <sup>2</sup>
Küche	21,34 m <sup>2</sup>
Wohnen	21,10 m <sup>2</sup>
WC	1,71 m <sup>2</sup>
Treppe	3,92 m <sup>2</sup>
EG	54,38 m <sup>2</sup>

Erdgeschoss

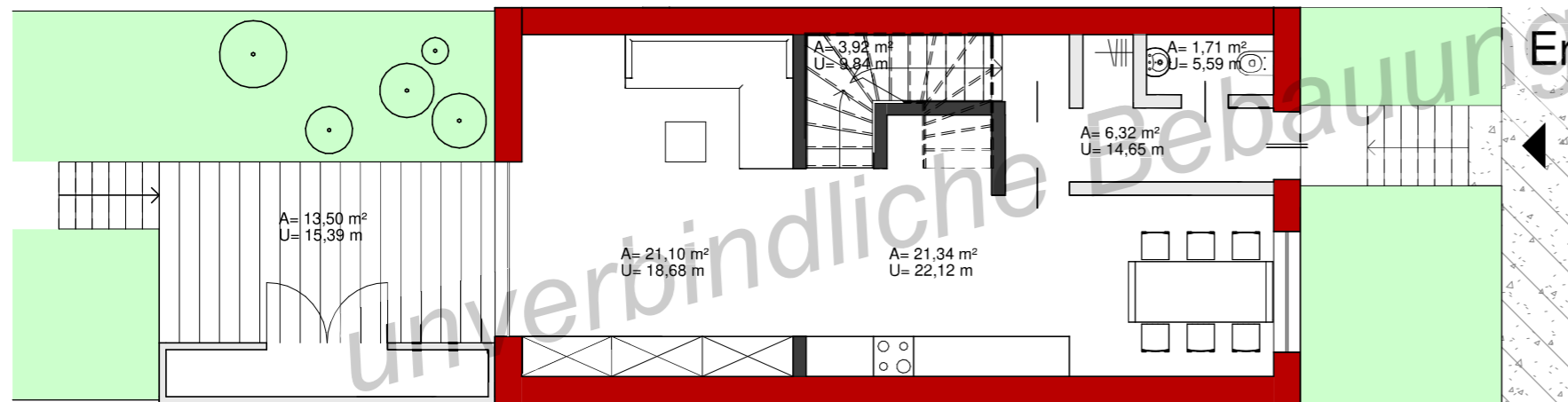

Flur	8,04 m <sup>2</sup>
Raum	15,00 m <sup>2</sup>
Raum	14,60 m <sup>2</sup>
Sanitär	6,81 m <sup>2</sup>
Raum	14,75 m <sup>2</sup>
Schlafen	15,15 m <sup>2</sup>
Treppe	5,48 m <sup>2</sup>
1.OG	79,83 m <sup>2</sup>
Gesamt: 13	190,28 m <sup>2</sup>

Kellergeschoss

